

Plataforma Elevadora E10

MEDIDAS PEANA

1250x1000

ESPACIO

PISABLE 1250x1000

ACCESO FRONTAL PUERTA DE MIRILLA

HUECO DE OBRA

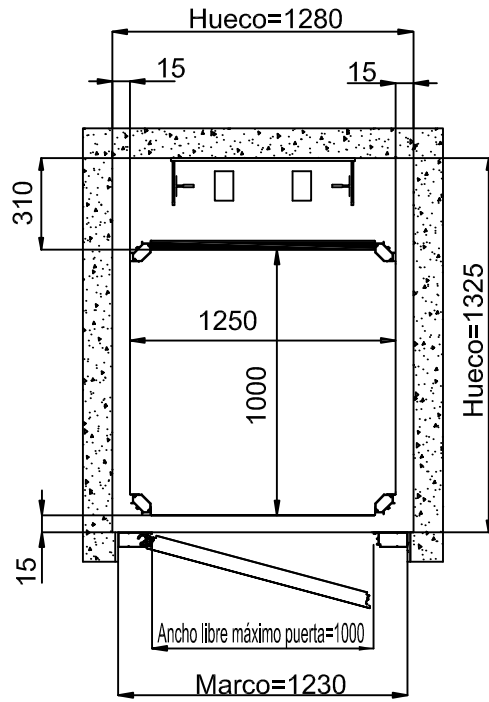
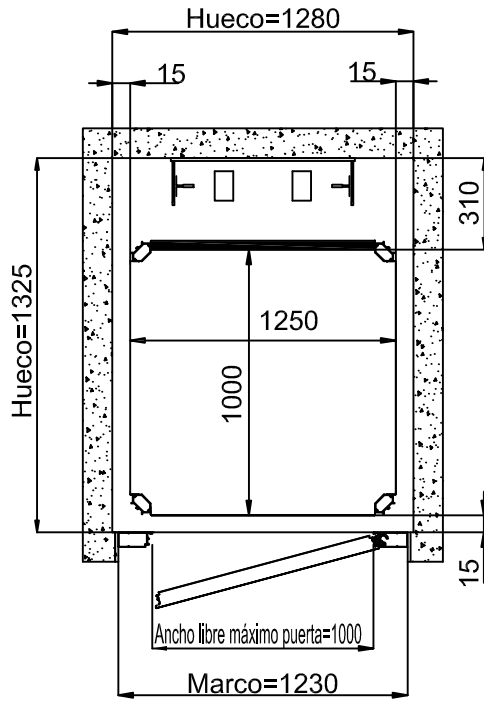

ACCESO FRONTAL PUERTA ALLUMINIO

ESTRUCTURA

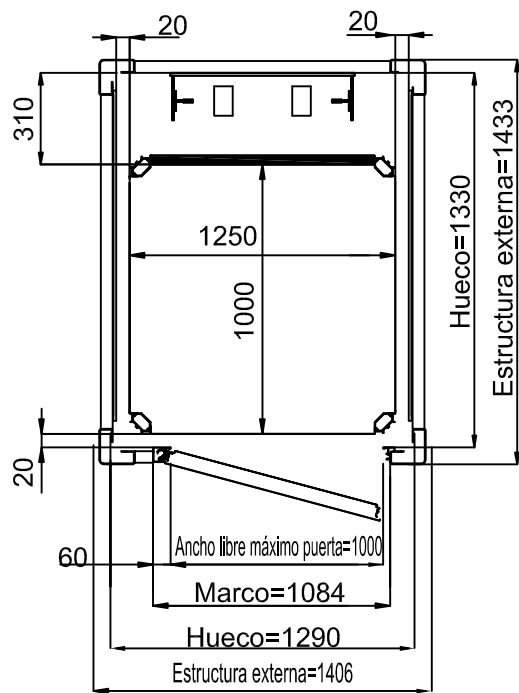
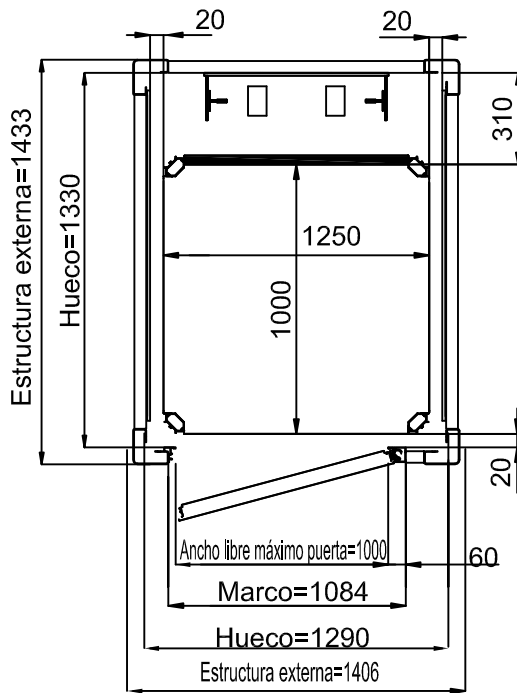

MEDIDAS EN MM

DATA	CODICE	Rev.
19-12-12	8643302	

MEDIDAS PEANA
1250x1000
ESPACIO
PISABLE 1250x1000

ACCESO LATERAL PUERTA DE MIRILLA
HUECO DE OBRA

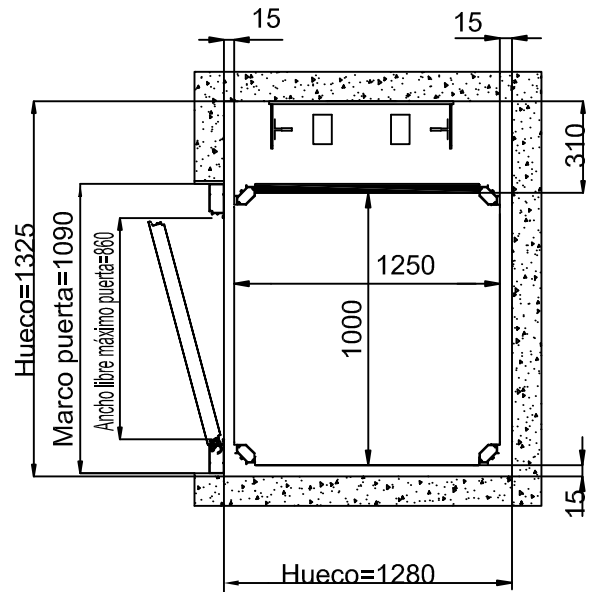
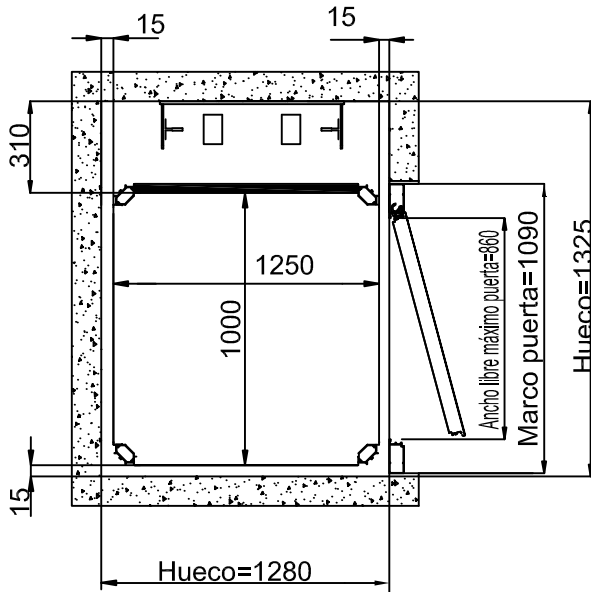

ACCESO LATERAL PUERTA ALLUMINIO
ESTRUCTURA

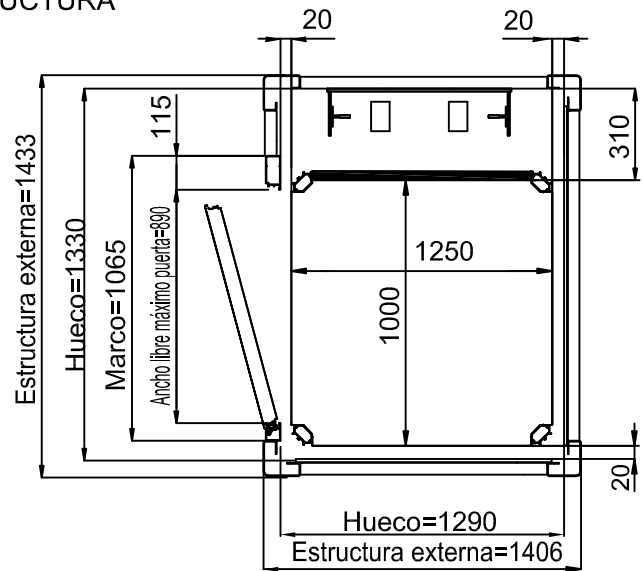
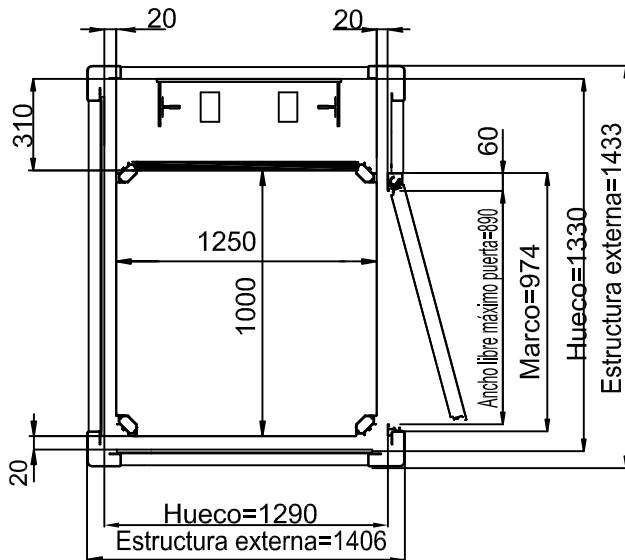

MEDIDAS EN MM

Plataforma Elevadora E10

MEDIDAS PEANA
1400x1100

ESPACIO
PISABLE 1400x1100

ACCESO FRONTAL PUERTA DE MIRILLA
HUECO DE OBRA

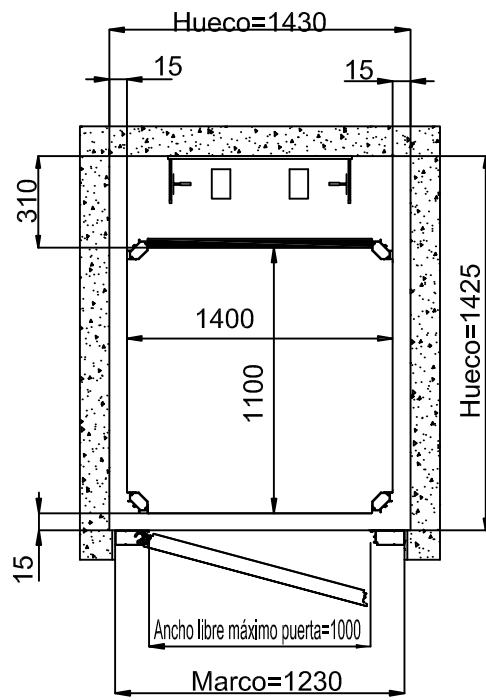
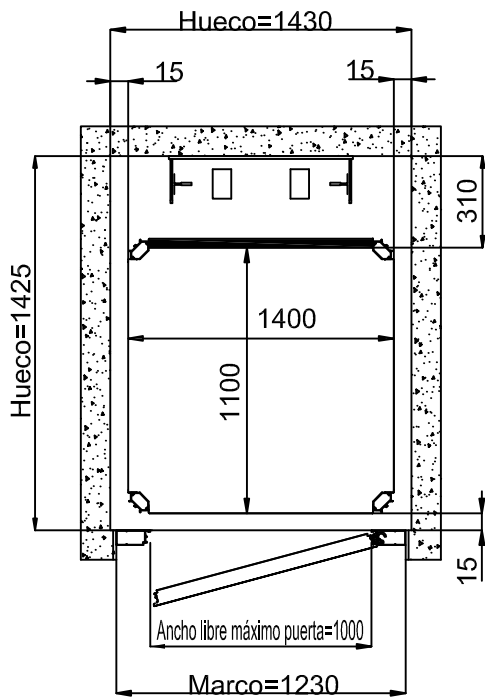

ACCESO FRONTAL PUERTA ALLUMINIO
ESTRUCTURA

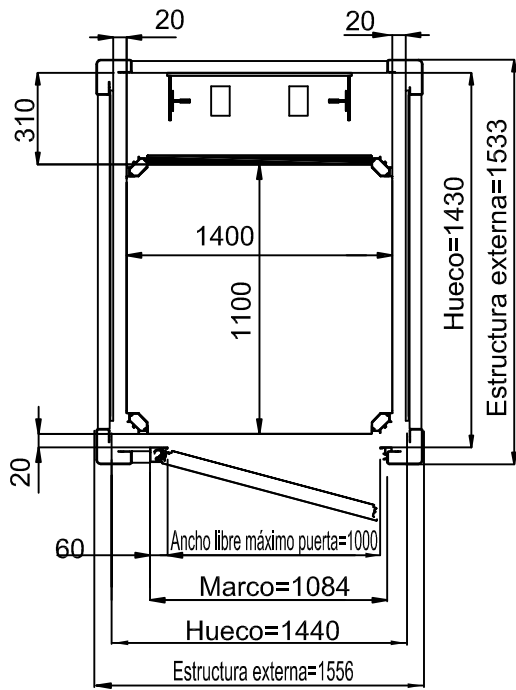
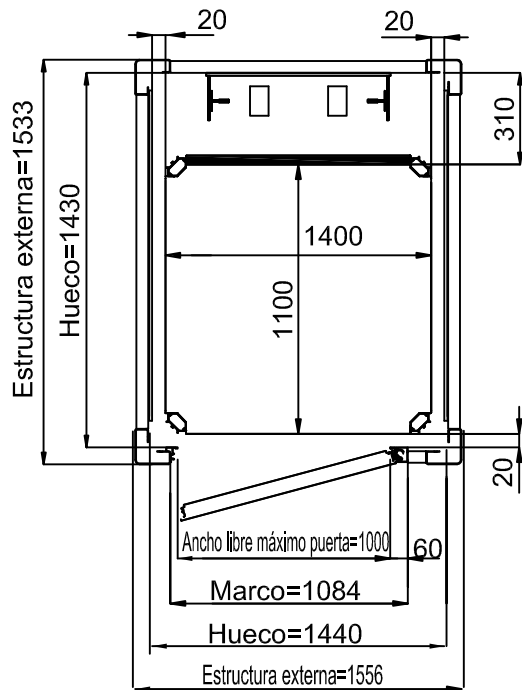

MEDIDAS EN MM

DATA	CODICE	Rev.
19-12-12	8643302	

MEDIDAS PEANA
1400x1100
ESPACIO
PISABLE 1400x1100

ACCESO LATERAL PUERTA DE MIRILLA
HUECO DE OBRA

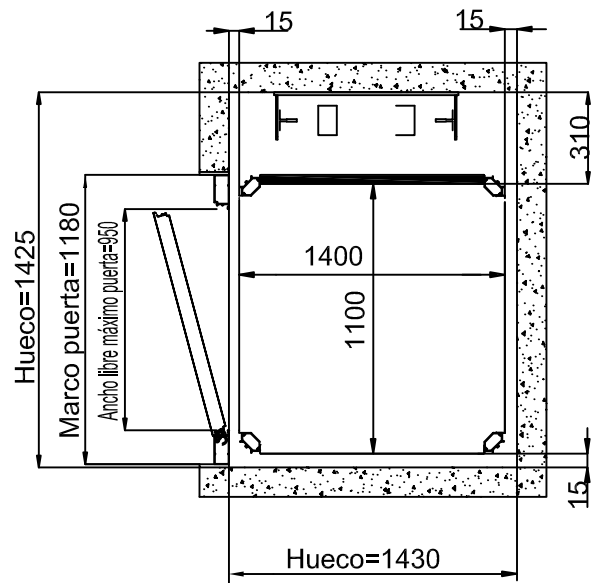
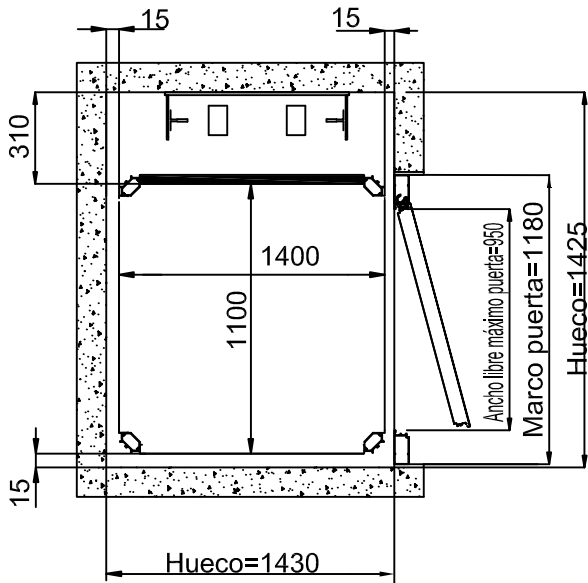

ACCESO LATERAL PUERTA ALLUMINIO
ESTRUCTURA

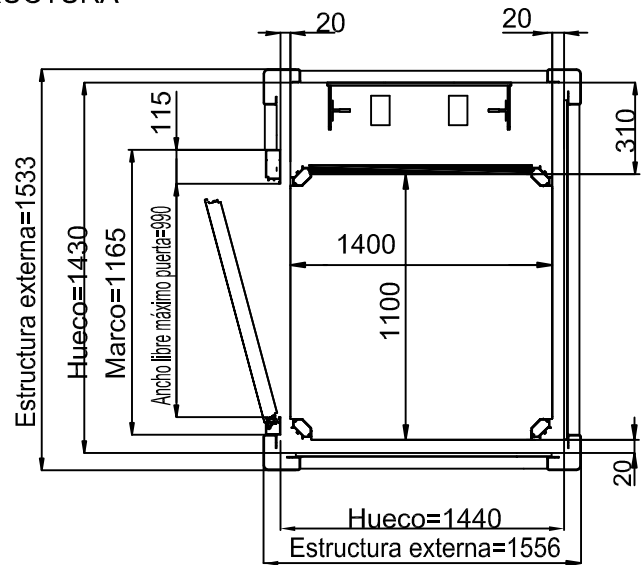
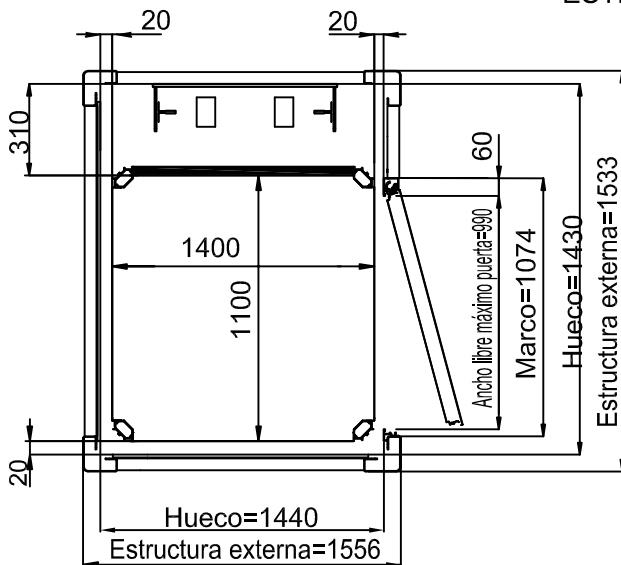

MEDIDAS EN MM

Plataforma Elevadora E10

MEDIDAS PEANA

1250x1000

ESPACIO

PISABLE 1190x1000

ACCESO FRONTAL PUERTA DE MIRILLA

HUECO DE OBRA

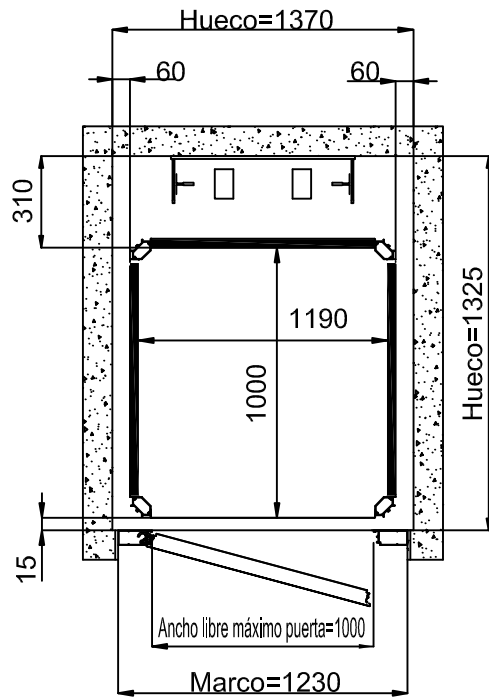
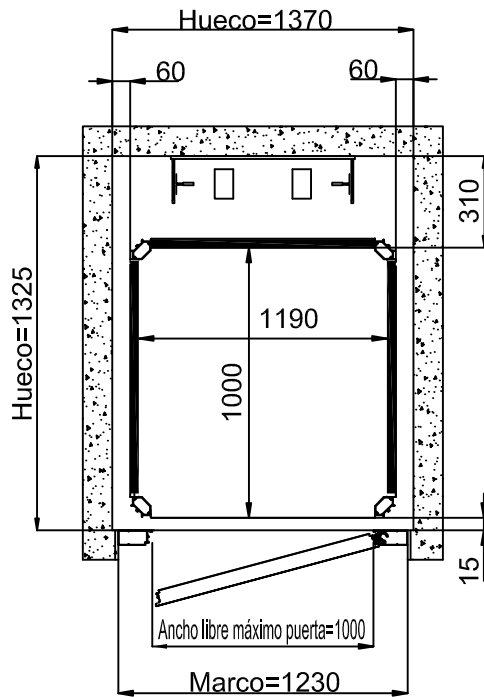

ACCESO FRONTAL PUERTA ALLUMINIO

ESTRUCTURA

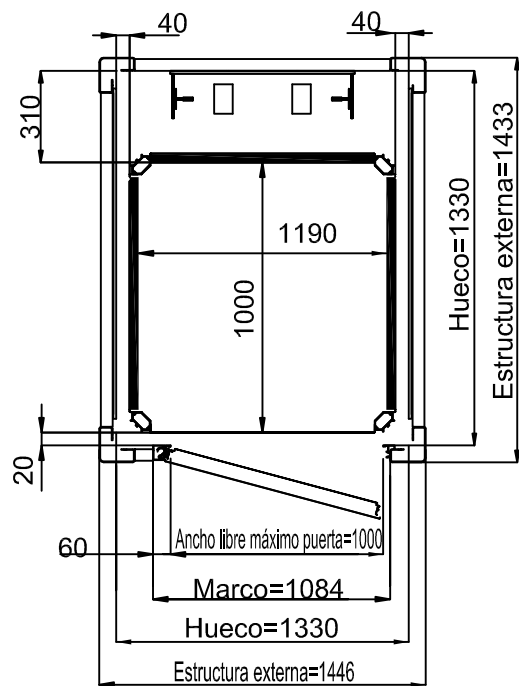
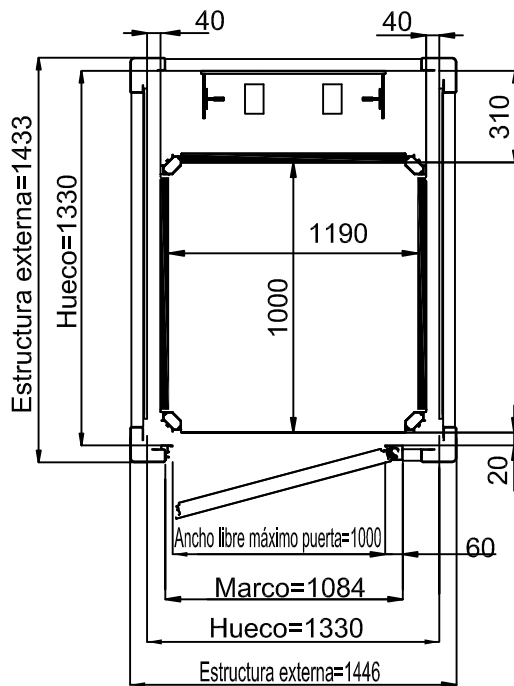

MEDIDAS EN MM

DATA	CODICE	Rev.
19-12-12	8643302	

MEDIDAS PEANA
1250x1000
ESPACIO
PISABLE 1220x970

ACCESO LATERAL PUERTA DE MIRILLA
HUECO DE OBRA

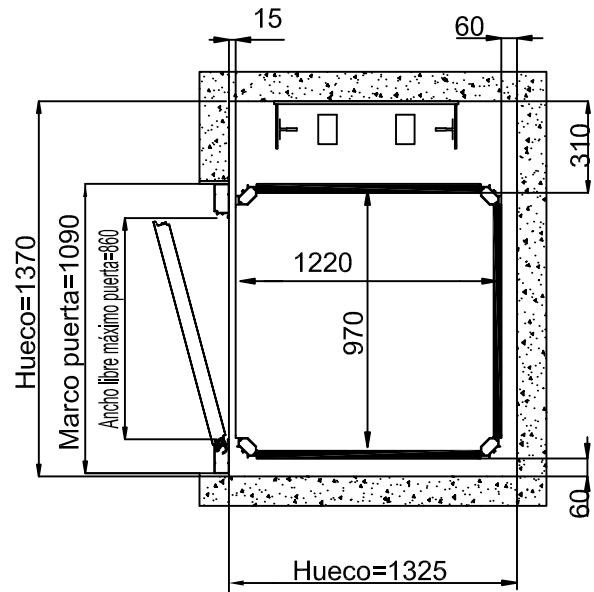
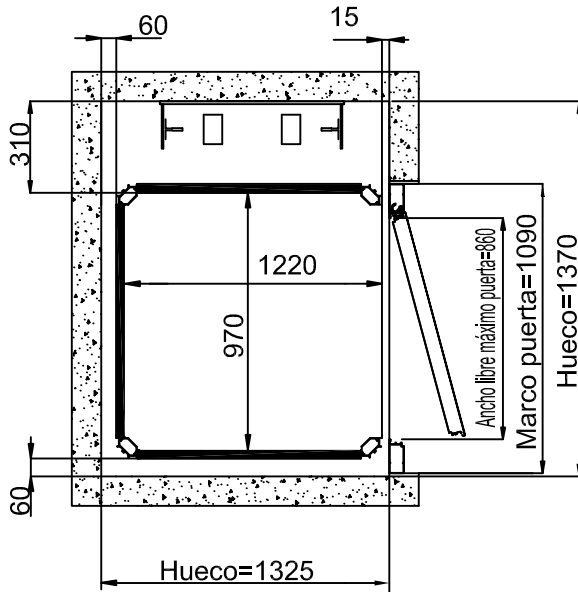

ACCESO LATERAL PUERTA ALLUMINIO
ESTRUCTURA

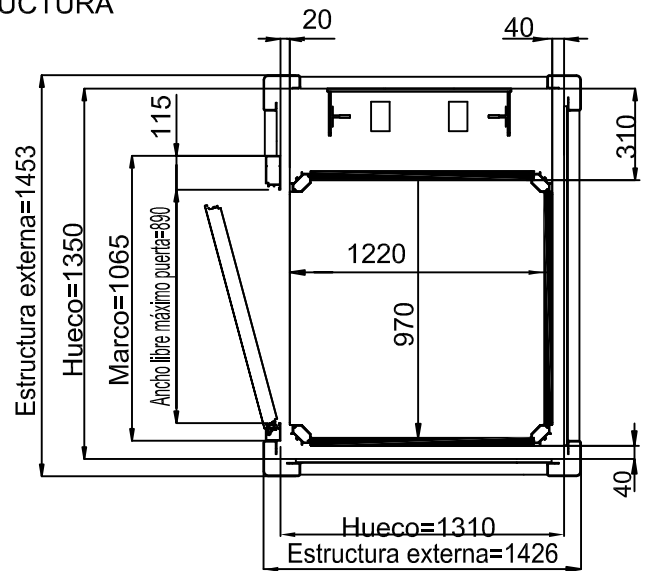
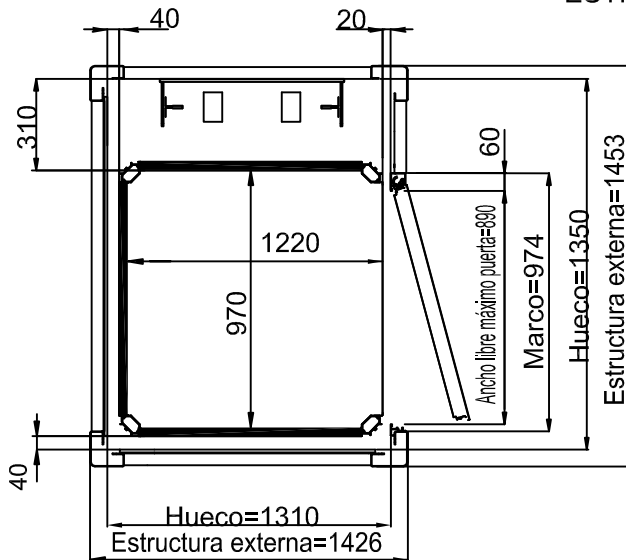

MEDIDAS EN MM

DATA	CODICE	Rev.
19-12-12	8643302	

MEDIDAS PEANA

1400x1100

ESPACIO

PISABLE 1340x1100

ACCESO FRONTAL PUERTA DE MIRILLA

HUECO DE OBRA

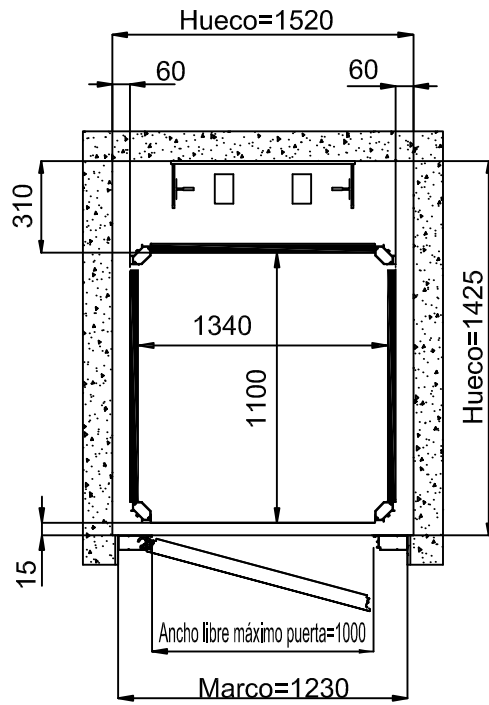
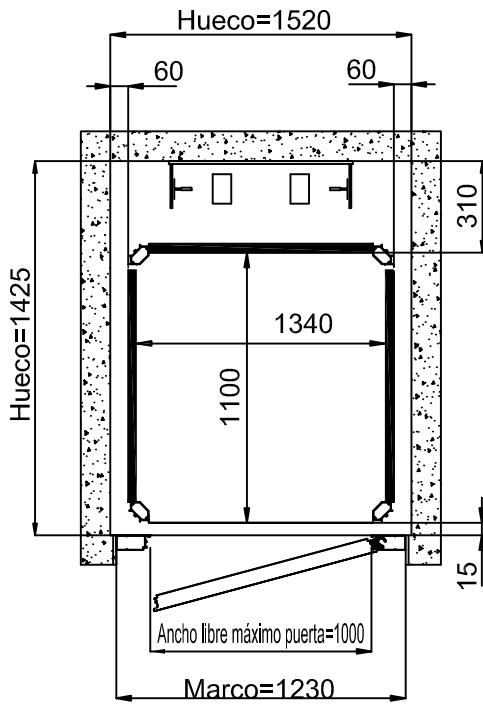

ACCESO FRONTAL PUERTA ALLUMINIO

ESTRUCTURA

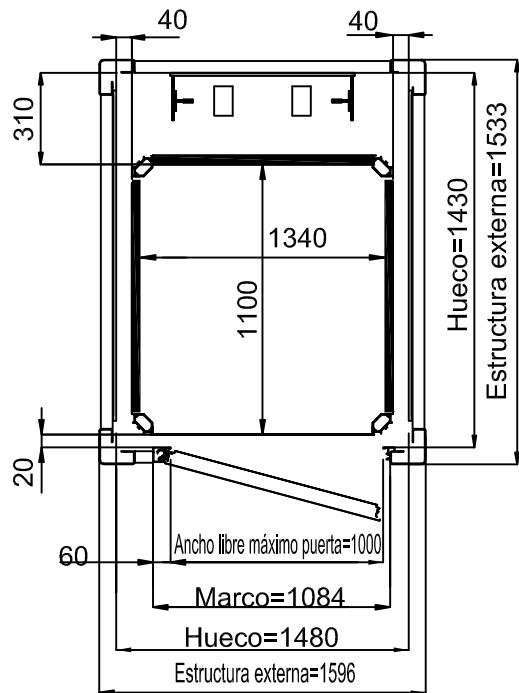
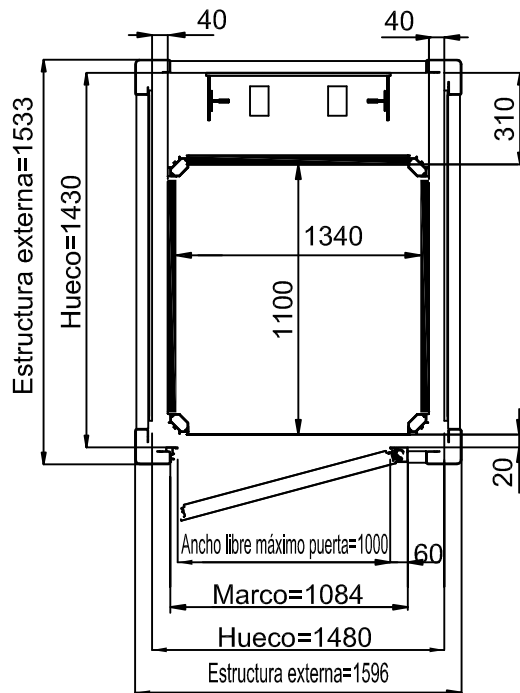

MEDIDAS EN MM

DATA	CODICE	Rev.
19-12-12	8643302	

MEDIDAS PEANA
1400x1100
ESPACIO
PISABLE 1370x1070

ACCESO LATERAL PUERTA DE MIRILLA
HUECO DE OBRA

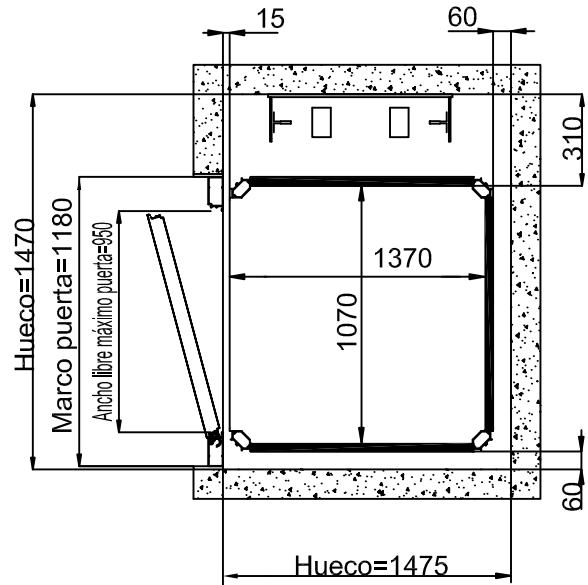
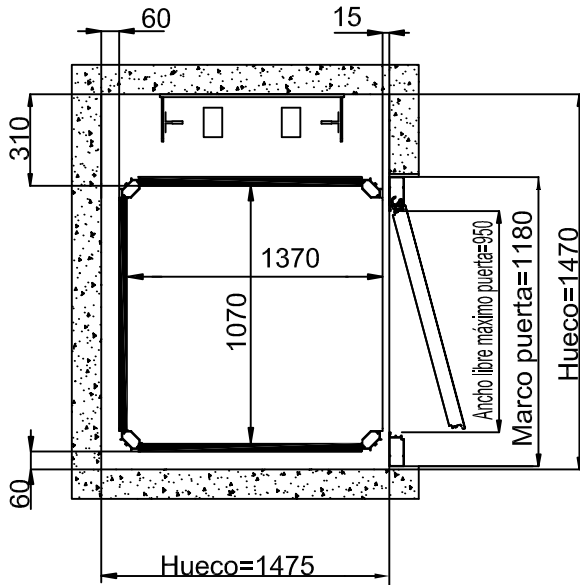

ACCESO LATERAL PUERTA ALLUMINIO
ESTRUCTURA

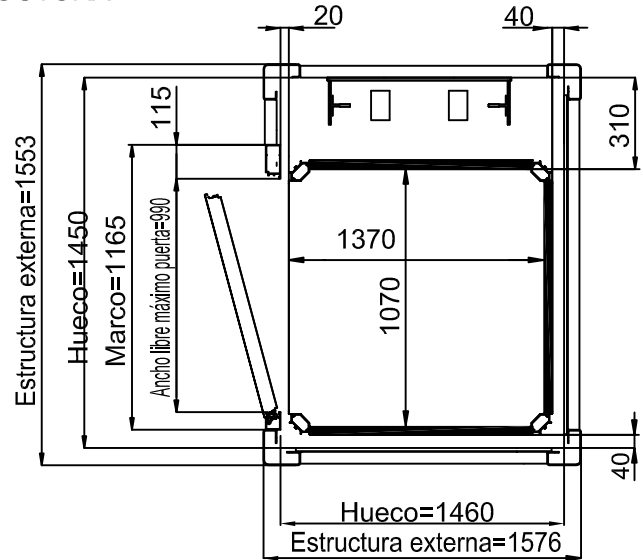
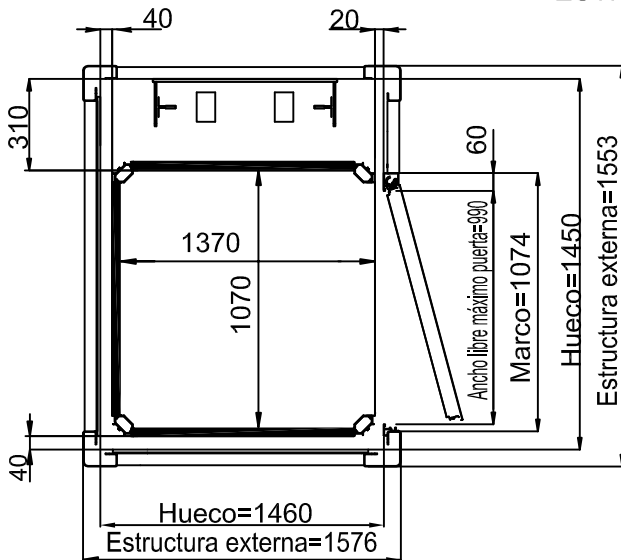

MEDIDAS EN MM

DATA	CODICE	Rev.
19-12-12	8643302	

MEDIDAS PEANA
1250x1000

PUERTA TELESCÓPICA 750 mm (FERMATOR)

ESPACIO

PISABLE 1190x970

HUECO DE OBRA

ACCESO LATERAL

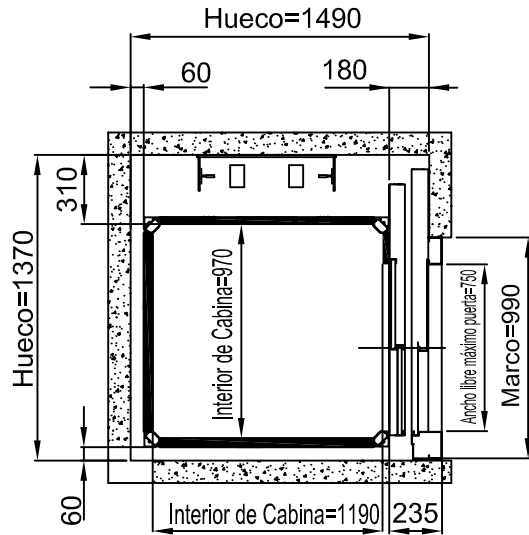

ACCESOS A 180 GRADOS

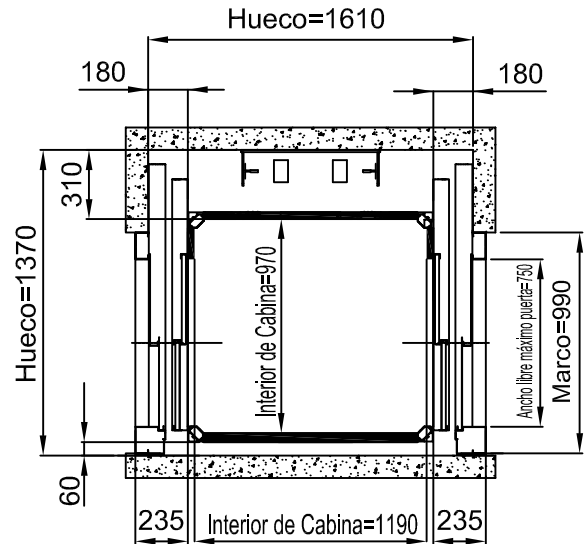

ACCESO FRONTAL PUERTA LATERAL DERECHA - IZQUIERDA

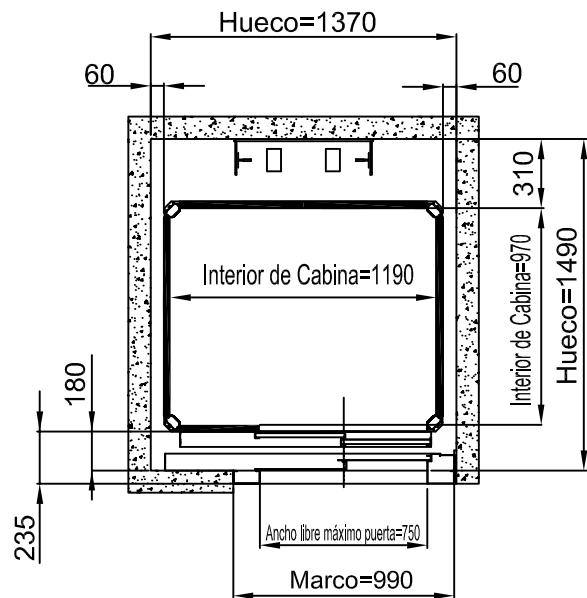
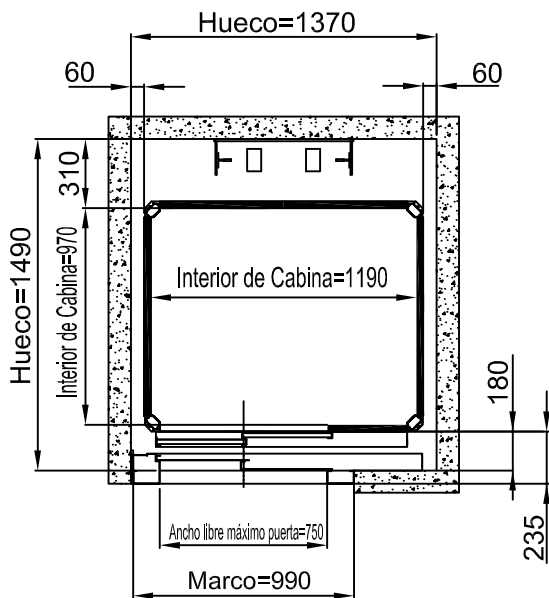

MEDIDAS EN MM

DATA	CODICE	Rev.
19-12-12	8643302	

MEDIDAS PEANA
1250x1000
PUERTA TELESCÓPICA 750 mm (FERMATOR)

ESPACIO
PISABLE 1190x970

ESTRUCTURA

ACCESO LATERAL

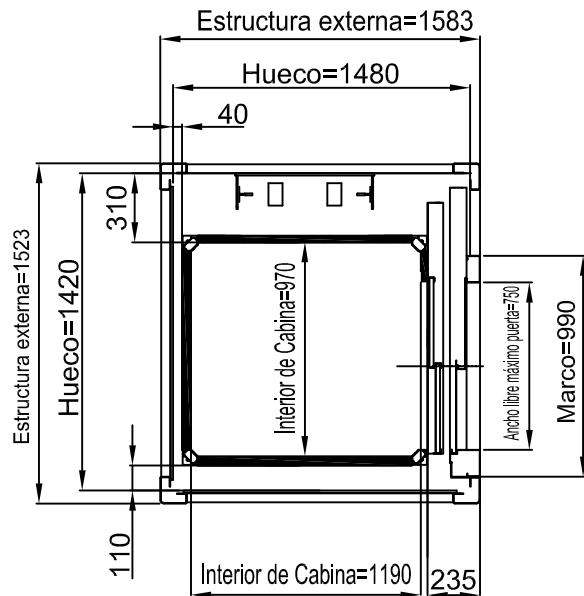

ACCESOS A 180 GRADOS

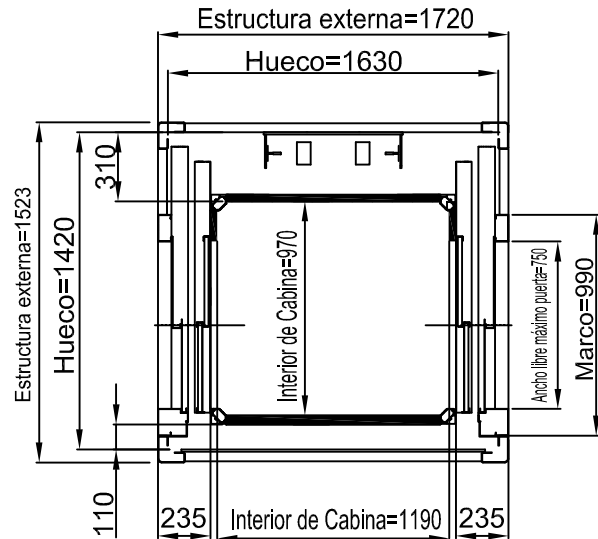

ACCESO FRONTAL PUERTA LATERAL DERECHA - IZQUIERDA

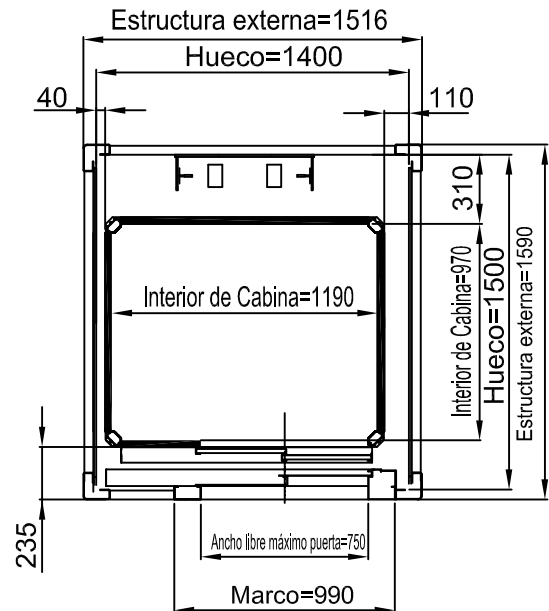
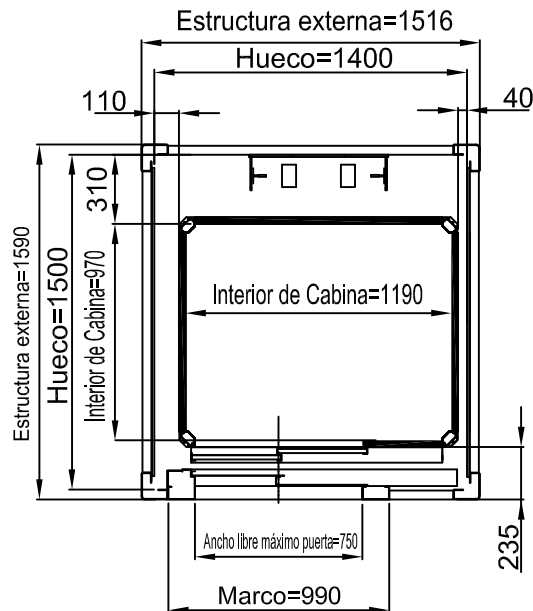

MEDIDAS EN MM

MEDIDAS PEANA
1400x1100

PUERTA TELESCÓPICA 800 mm (FERMATOR)

ESPACIO

PISABLE 1340x1070

HUECO DE OBRA

ACCESO LATERAL

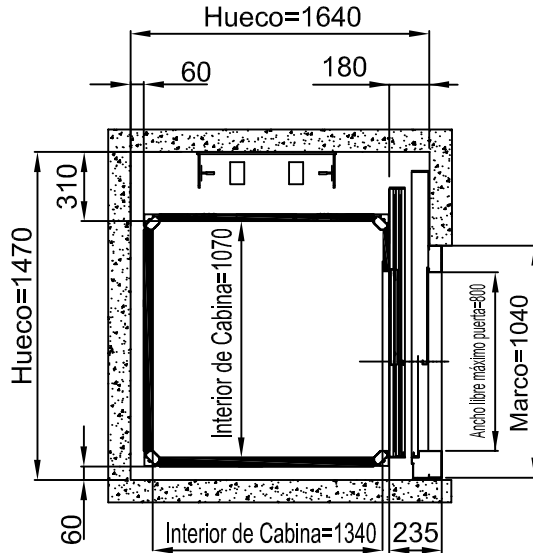

ACCESOS A 180 GRADOS

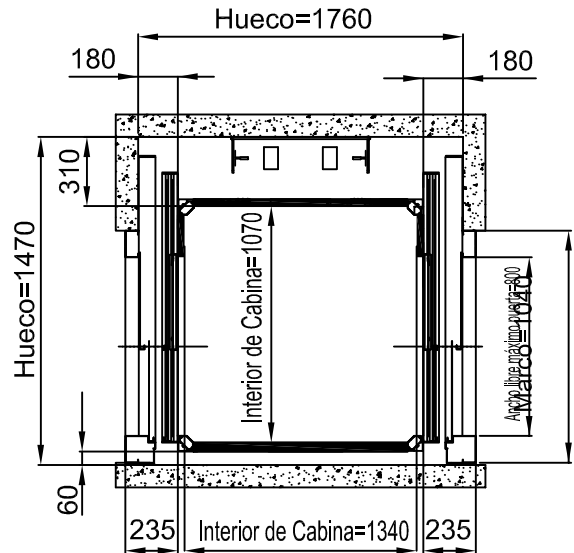

ACCESO FRONTAL PUERTA LATERAL DERECHA - IZQUIERDA

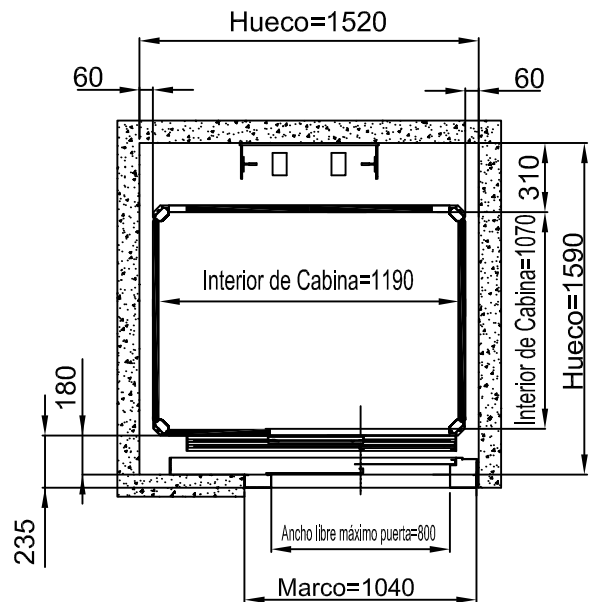
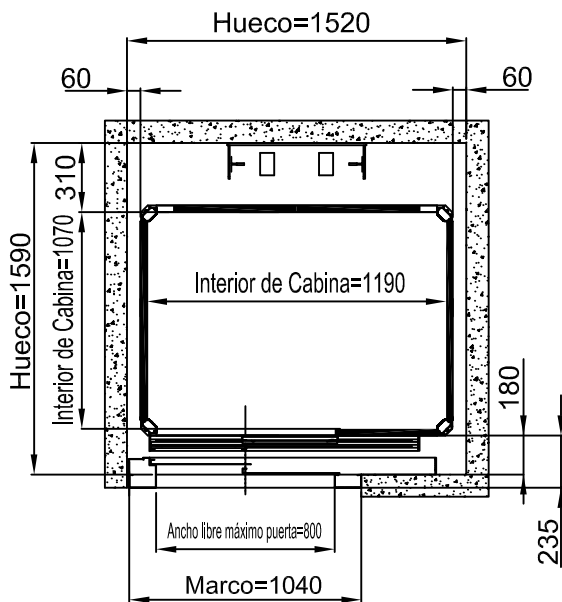

MEDIDAS EN MM

MEDIDAS PEANA

1400x1100

PUERTA TELESCÓPICA 800 mm (FERMATOR)

**ESPACIO
PISABLE**

1340x1070

ESTRUCTURA

ACCESO LATERAL

ACCESOS A 180 GRADOS

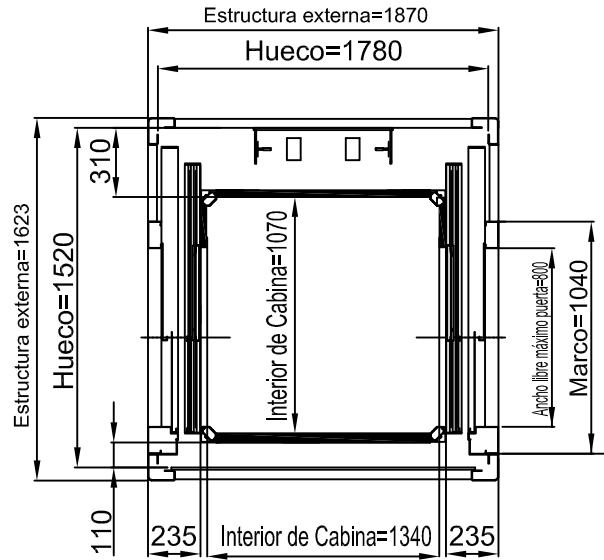
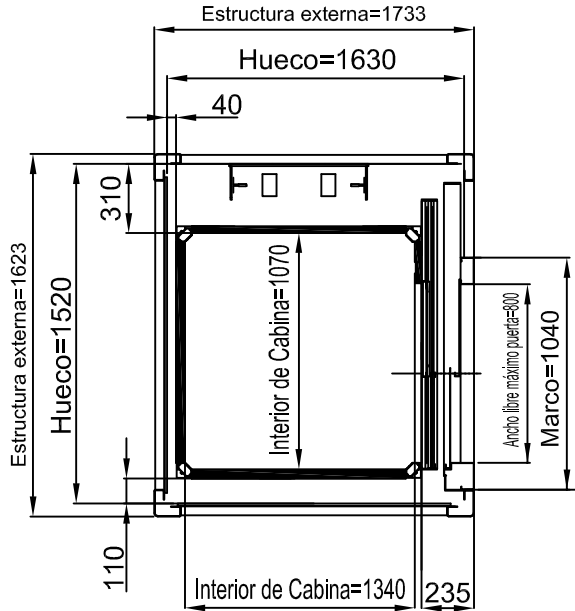

ACCESO FRONTAL PUERTA LATERAL DERECHA - IZQUIERDA

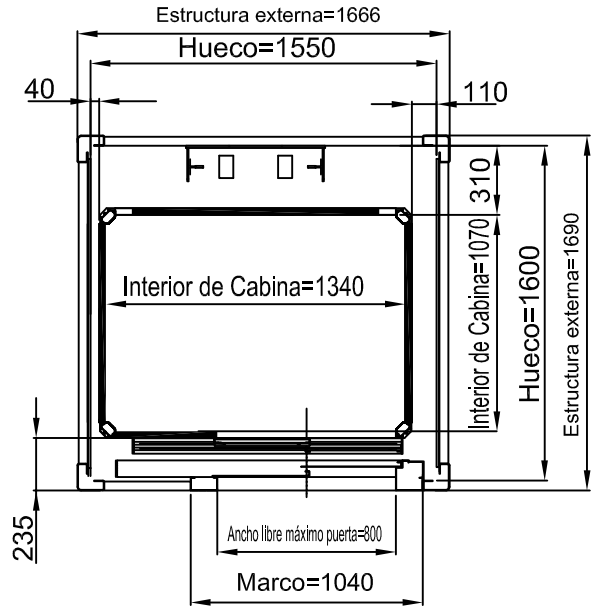
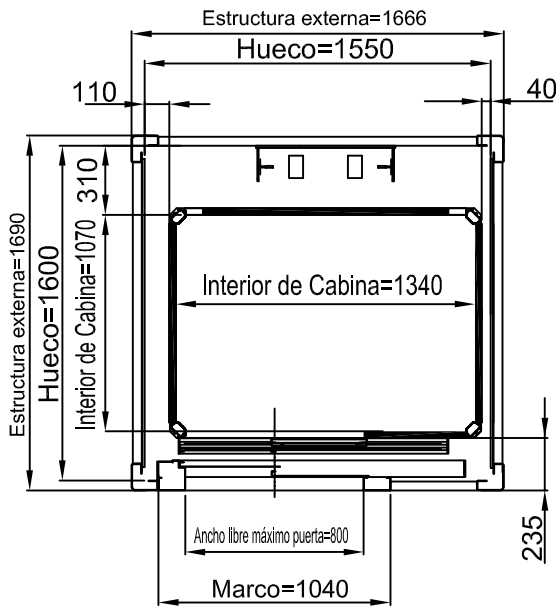

MEDIDAS EN MM

DATA	CODICE	Rev.
19-12-12	8643302	

MEDIDAS PEANA

1300x1030

PUERTA TELESCÓPICA 800 mm (FERMATOR)

ESPACIO

PISABLE 1240x1000

HUECO DE OBRA

ACCESO LATERAL

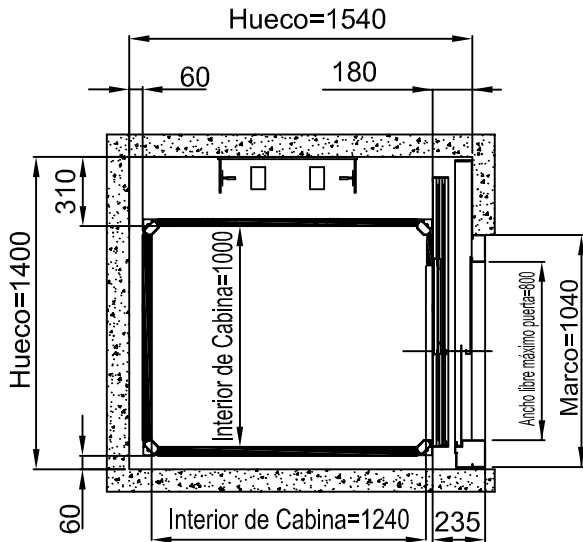

ACCESOS A 180 GRADOS

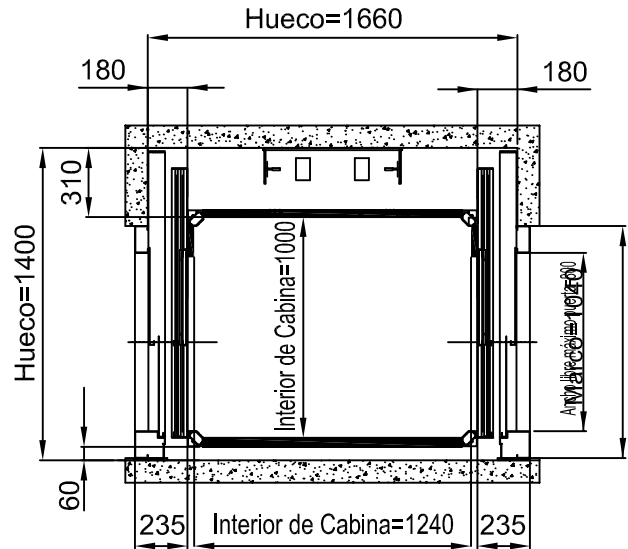

ACCESO FRONTAL PUERTA LATERAL DERECHA - IZQUIERDA

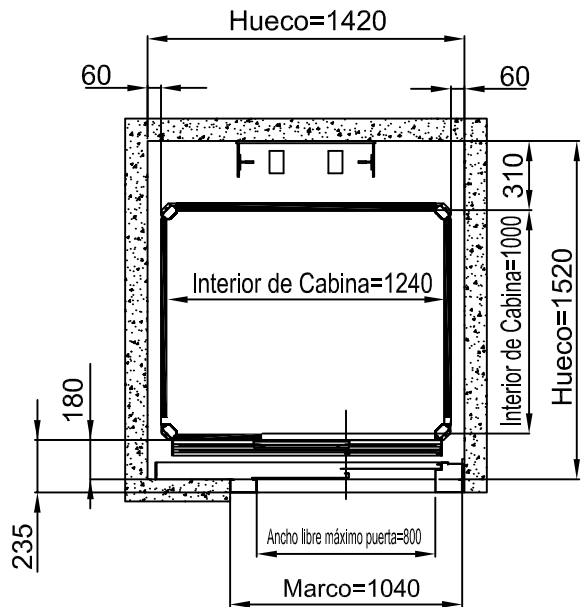
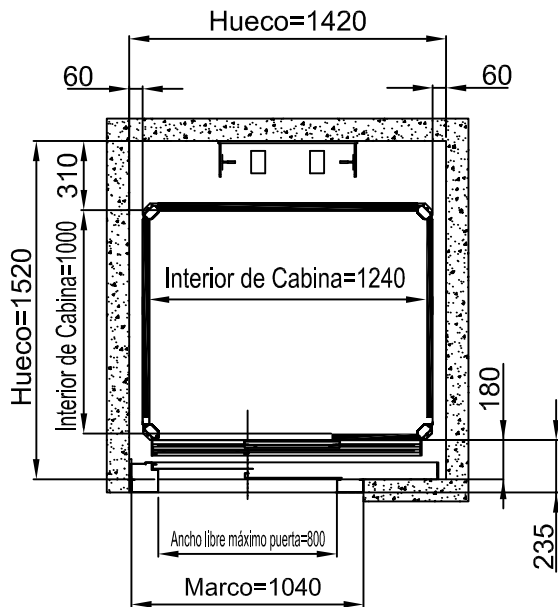

MEDIDAS EN MM

DATA	CODICE	
19-12-12	8643302	

MEDIDAS PEANA

1300x1030

PUERTA TELESCÓPICA 800 mm (FERMATOR)

ESPACIO

PISABLE 1240x1000

ESTRUCTURA

ACCESO LATERAL

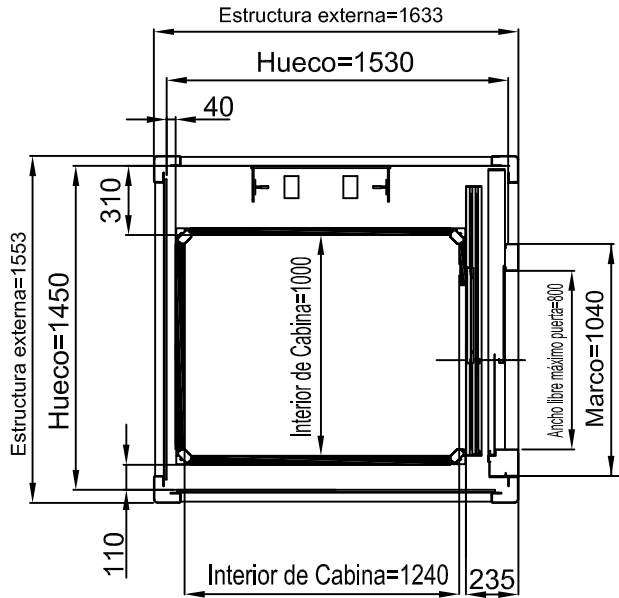

ACCESOS A 180 GRADOS

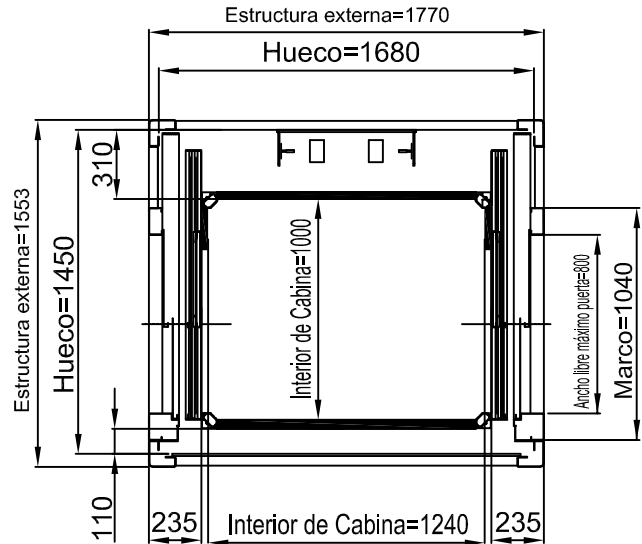

ACCESO FRONTAL PUERTA LATERAL DERECHA - IZQUIERDA

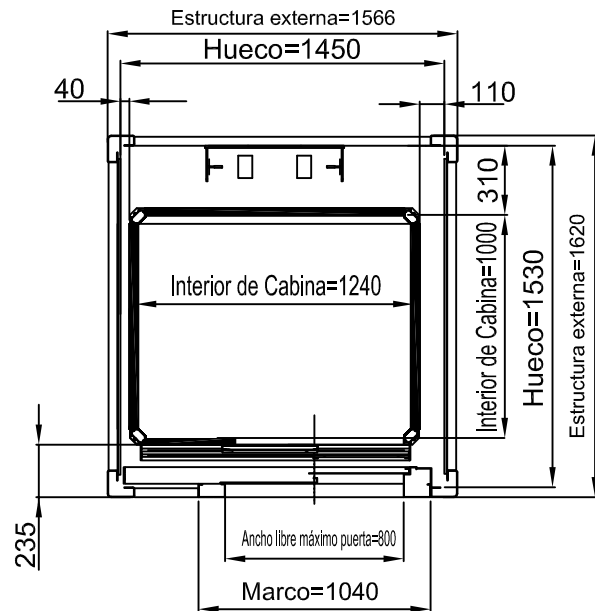
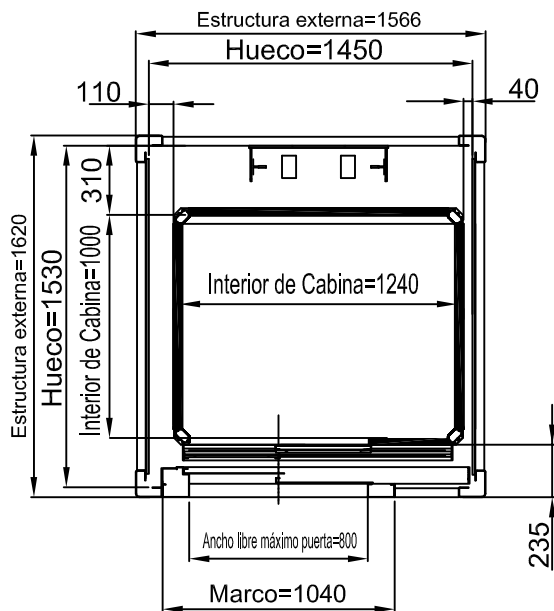

MEDIDAS EN MM

DATA	CODICE	Rev.
19-12-12	8643302	

MEDIDAS PEANA

1460x1170

PUERTA TELESCÓPICA 900 mm (FERMATOR)

ESPACIO

HUECO DE OBRA

PISABLE

1400x1140

ACCESO LATERAL

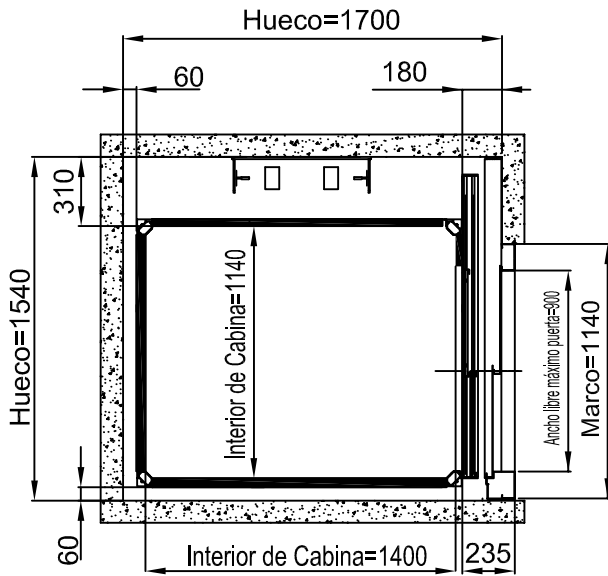

ACCESOS A 180 GRADOS

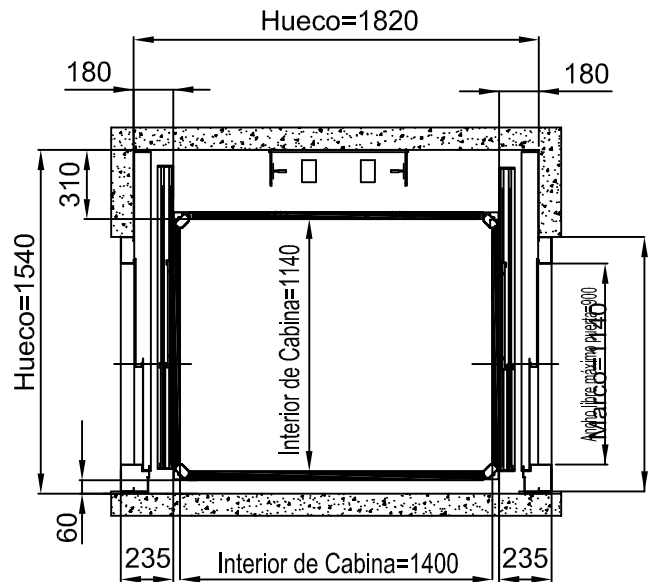

ACCESO FRONTAL PUERTA LATERAL DERECHA - IZQUIERDA

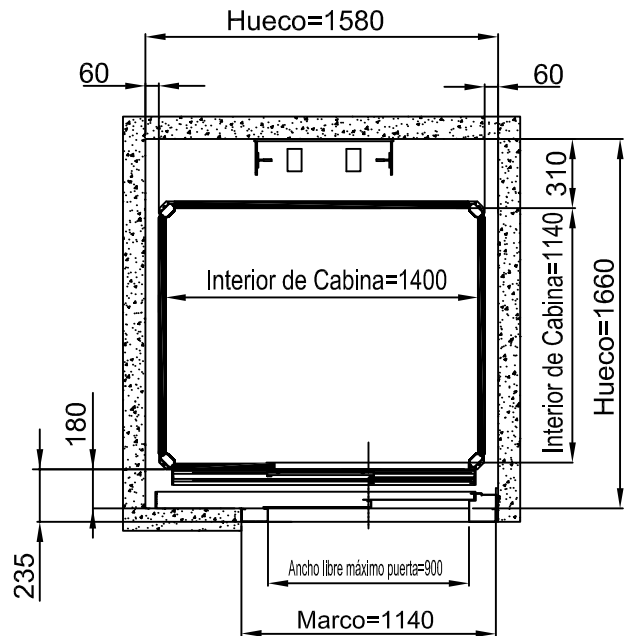
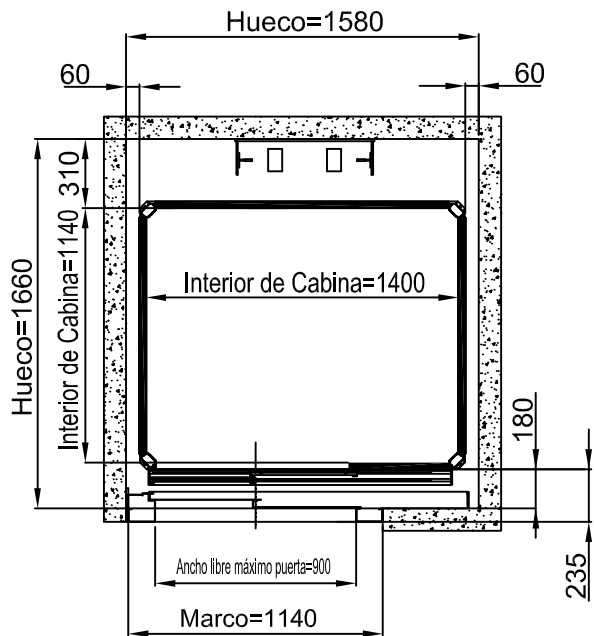

MEDIDAS EN MM

MEDIDAS PEANA
1460x1170

PUERTA TELESCÓPICA 900 mm (FERMATOR)

ESPACIO

ESTRUCTURA

PISABLE 1400x1140

ACCESO LATERAL

ACCESOS A 180 GRADOS

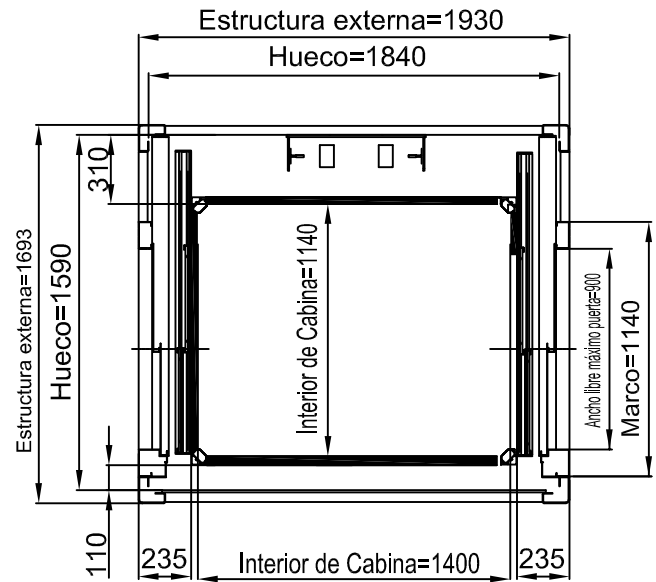
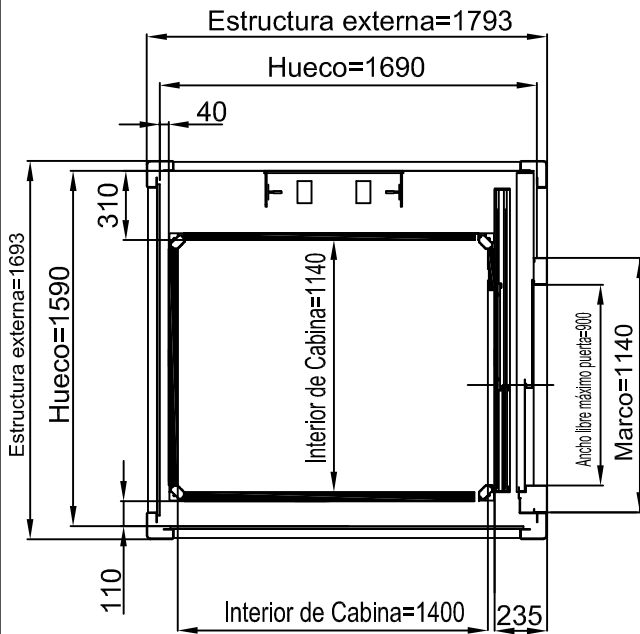

ACCESO FRONTAL PUERTA LATERAL DERECHA - IZQUIERDA

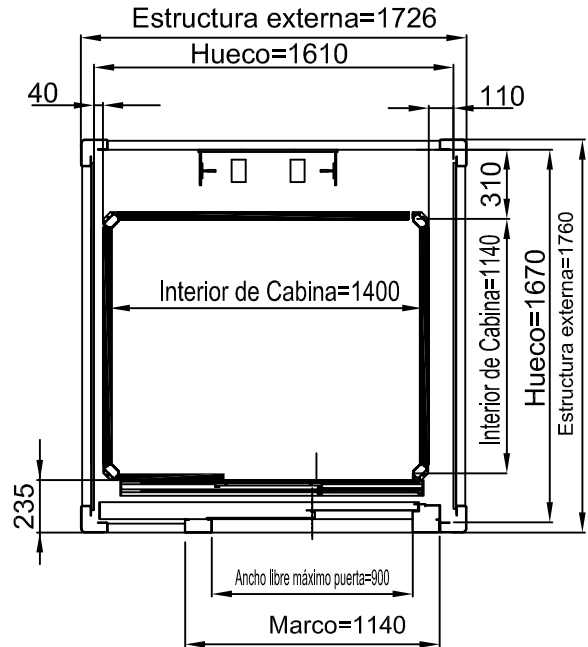
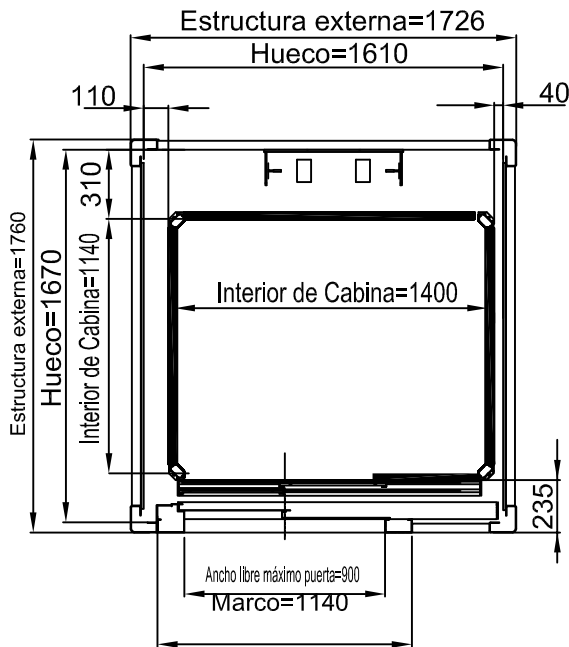

MEDIDAS EN MM

DATA	CODICE	Rev.
19-12-12	8643302	

TIPOS DE PUERTAS

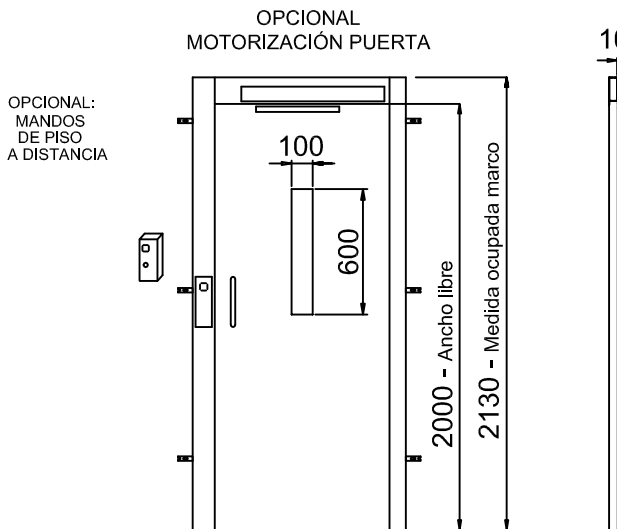

PUERTA DE MIRILLA

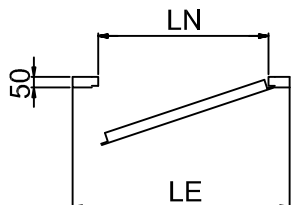

LN	LE
600	830
650	880
700	930
750	980
800	1030
860	1090
900	1130
950	1180
1000	1230

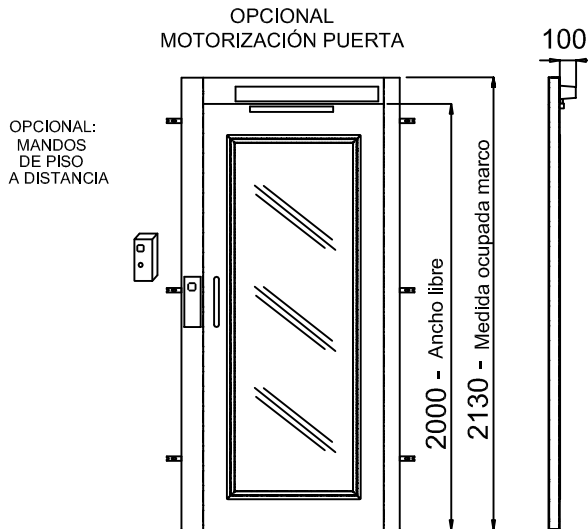

PUERTA PANORÁMICA DE CHAPA

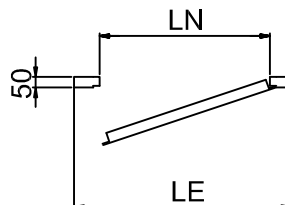

LN	LE
800	1030
860	1090
900	1130

LN = ANCHO LIBRE

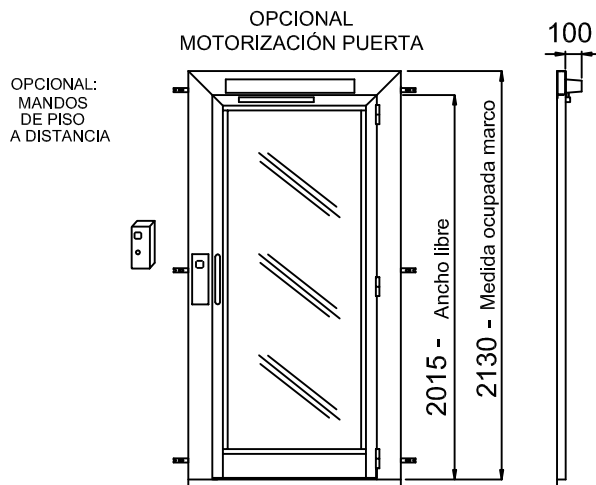

PUERTA PANORÁMICA DE ALLUMINIO

LN	LE
600	830
650	880
700	930
750	980
800	1030
860	1090
900	1130
950	1180
1000	1230

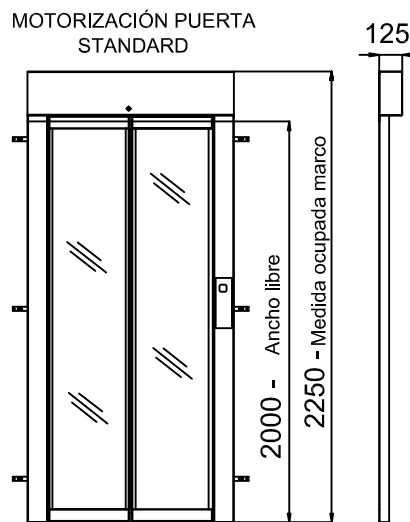
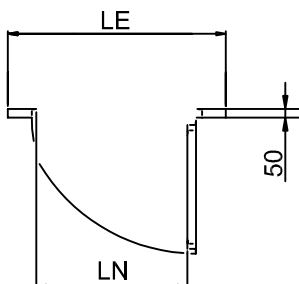

PUERTA DE DOBLE HOJA PANORÁMICA

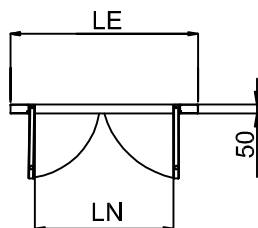

LN	LE
Spec. 750	1030
800	1080
860	1130
900	1180
Spec. 950	1230

TIPOS DE PUERTAS TELESCÓPICAS

PUERTA LATERAL CIERRE IZQUIERDO

NO HAY TECLADO EN LAS PUERTAS "EI"

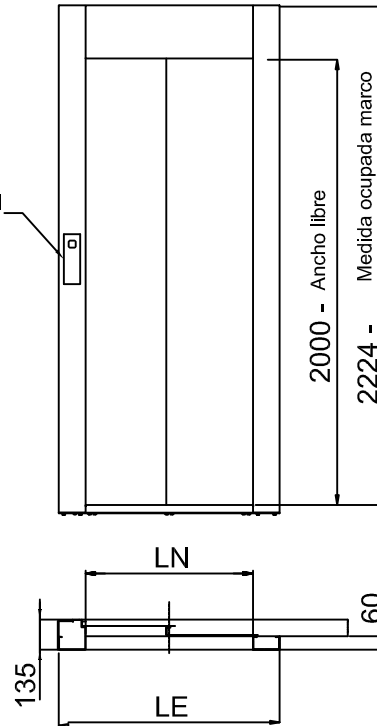

LN	LE
700	940
750	990
800	1040
900	1140

LN = ANCHO LIBRE

PUERTA LATERAL CIERRE DERECHO

NO HAY TECLADO EN LAS PUERTAS "EI"

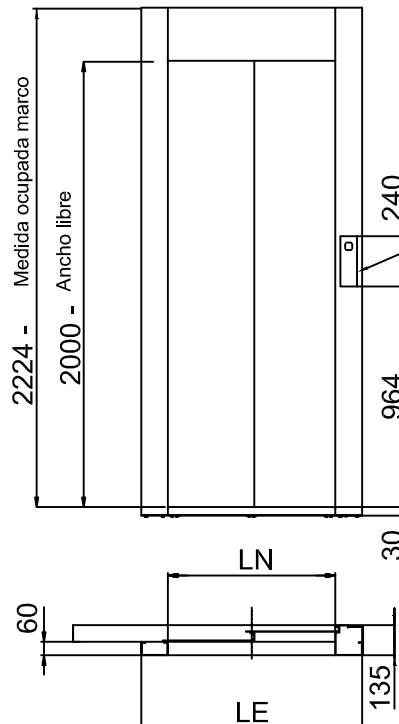

LN	LE
700	940
750	990
800	1040
900	1140

PUERTA DE MIRILLA

VISTA FRONTAL Y LATERAL ELEVADOR (CON PROTECCIONES)

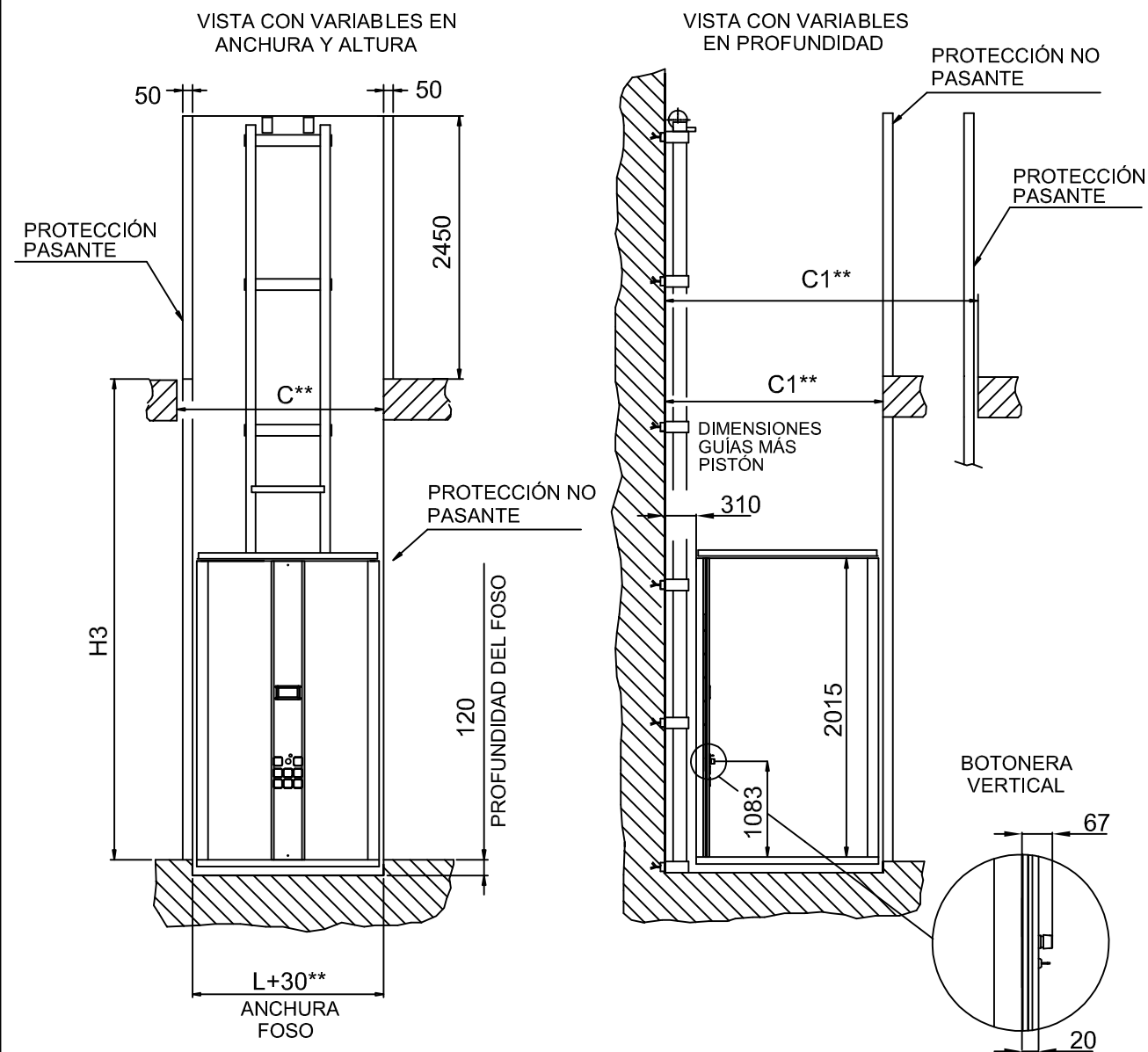

** AÑADA 45 MM DE CADA LADO CON PARED DE CABINA ADICIONAL

DIMENSIONES DE SERIE

C Anchura hueco	CON PROTECCIONES NO PASANTES O HUECO EN ALBAÑILERÍA	**	L+30
	CON UNA PROTECCIÓN PASANTE		L+90
	CON DOS PROTECCIONES PASANTES		L+150
C1 Profundidad hueco	CON PROTECCIONES NO PASANTES O HUECO EN ALBAÑILERÍA	**	P+325
	CON PROTECCIONES PASANTES		P+385

PUERTA TELESCÓPICA

VISTA FRONTAL Y LATERAL ELEVADOR (CON PROTECCIONES)

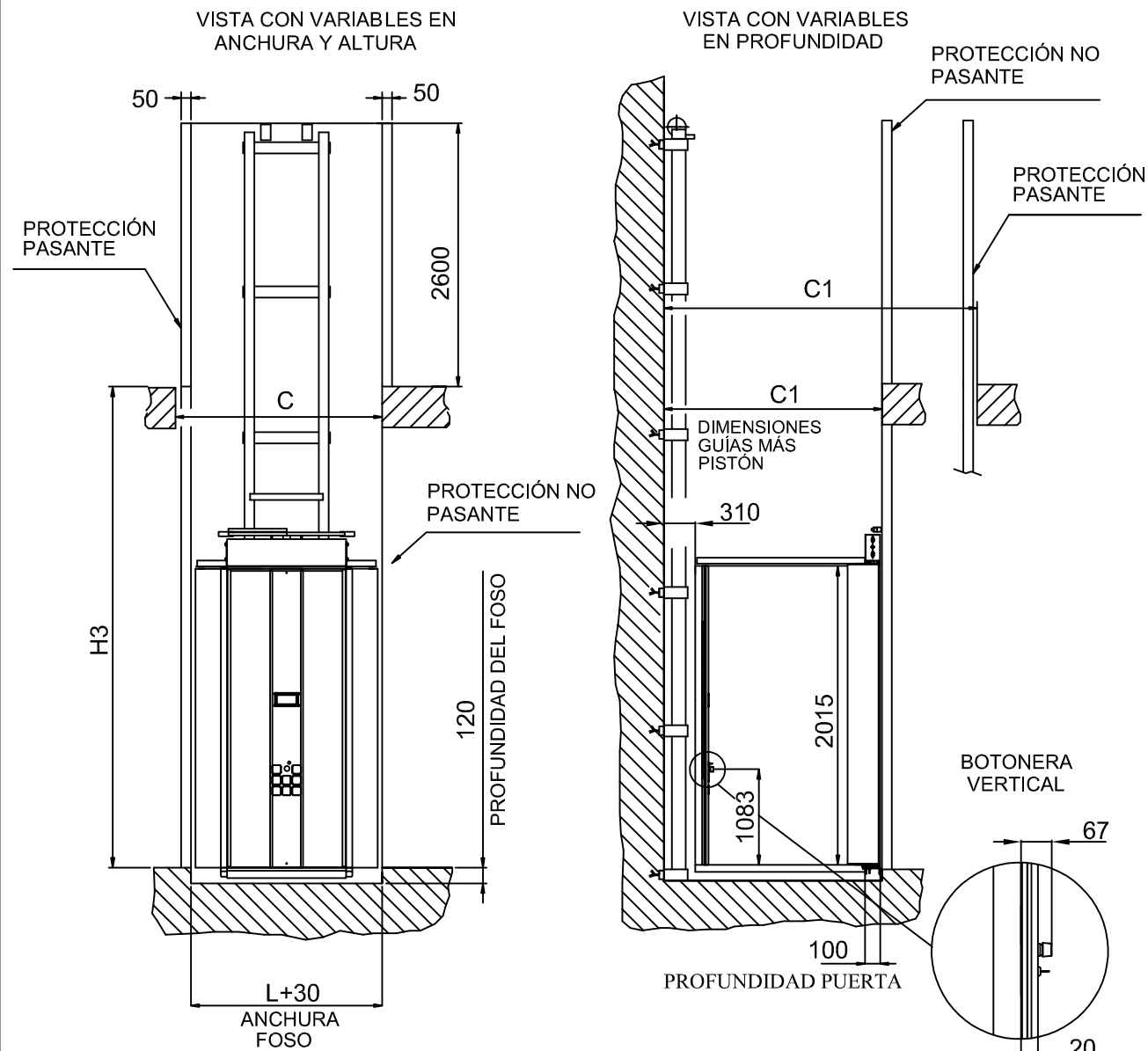

LAS PAREDES SIEMPRE ESTÁN PRESENTES CON PUERTA EN LA CABINA

DIMENSIONES CON PUERTA EN LA CABINA DE SERIE

C Anchura hueco	CON PROTECCIONES NO PASANTES O HUECO EN ALBAÑILERÍA	**	L+120
	CON UNA PROTECCIÓN PASANTE		L+180
	CON DOS PROTECCIONES PASANTES		L+240
C1 Profundidad hueco	CON PROTECCIONES NO PASANTES O HUECO EN ALBAÑILERÍA	**	P+425
	CON PROTECCIONES PASANTES		P+485